

# Acoustic Ceilings



## A Better Way to Reduce Noise in Architectural Spaces

A collection of textiles encompassing a range of textures that deliver exceptional acoustic performance, making them the perfect choice for stretch ceilings.



### Silence

Our highest rated acoustic performer with an NRC = 0.90



### Whisper

Superior acoustic performance with the option for UV printing:  
NRC = 0.85



### Serenity

Abrasion resistant, with a range of colors and printing options:  
NRC = 0.90

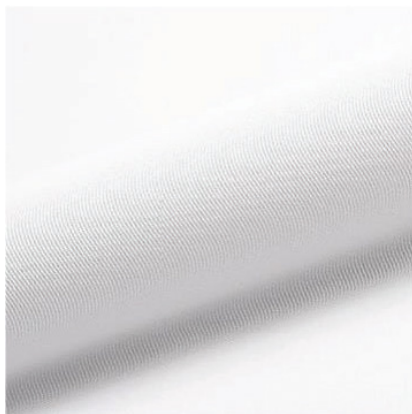

### Calm

Exceptional value with very good acoustic performance: NRC = 0.80

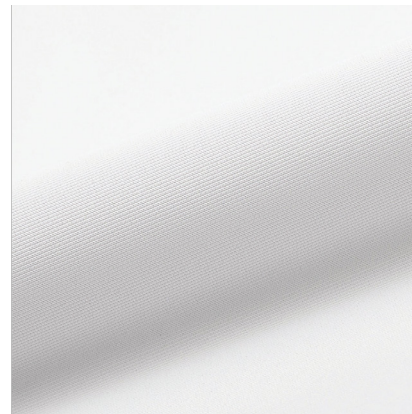

### 495D Retrofit

Look and feel of 495D (former Clipso part number) for retrofit applications

# Acoustic Ceilings



## Silence

Highest level of acoustic performance combined with a clean appearance.

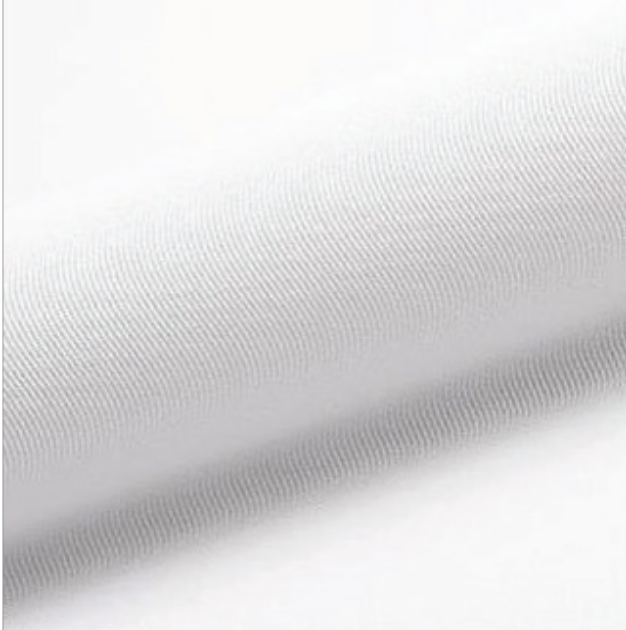

Color	White (WH)
Material	100% Knitted Polyester (Recyclable)
Widths (inches)	126 & 177
Acoustic Rating	NRC = 0.95
Fire Rating	ASTM E84 Class A
Printing Options	N/A
Cutting Methods	Cold, Ultrasonic, Heat
Order Code	STAT-SIL-xxx (xxx = width)

## Whisper

Superior acoustic performance with the option to print graphics, images, and more.



Color	White, Black, or Printed
Material	100% Knitted Trevira CS (Recyclable)
Widths (inches)	126, 165, 205
Acoustic Rating	NRC = 0.85
Fire Rating	ASTM E84 Class A
Printing Options	UV
Cutting Methods	Cold, Ultrasonic, Heat
Order Code	STAT-WHS-xxx (xxx = width)

# Acoustic Ceilings

## Serenity

Abrasion resistant, colors or printing, and unique texture combined together.



Color	White, Colors (11) or Printed
Material	100% Woven Polyester (Recyclable)
Widths (inches)	61 & 122
Acoustic Rating	NRC = 0.90
Fire Rating	ASTM E84 Class A
Printing Options	UV, Latex, Dyesub
Cutting Methods	Ultrasonic, Heat
Order Code	STAT-SRN-xxx (xxx = width)

## Calm

Very good acoustic performance that fits any budget.

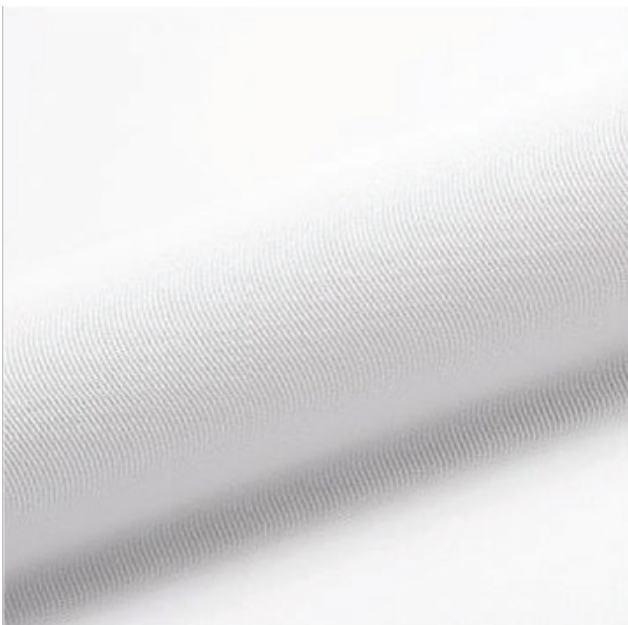

Color	White or Printed
Material	100% Knitted Polyester (Recyclable)
Widths (inches)	126 & 199
Acoustic Rating	NRC = 0.80
Fire Rating	ASTM E84 Class A
Printing Options	UV or Dyesub
Cutting Methods	Cold, Ultrasonic
Order Code	STAT-CLM-xxx (xxx = width)

## 495D Retrofit

Look and feel of 495D (former Clipso model) for retrofit applications.

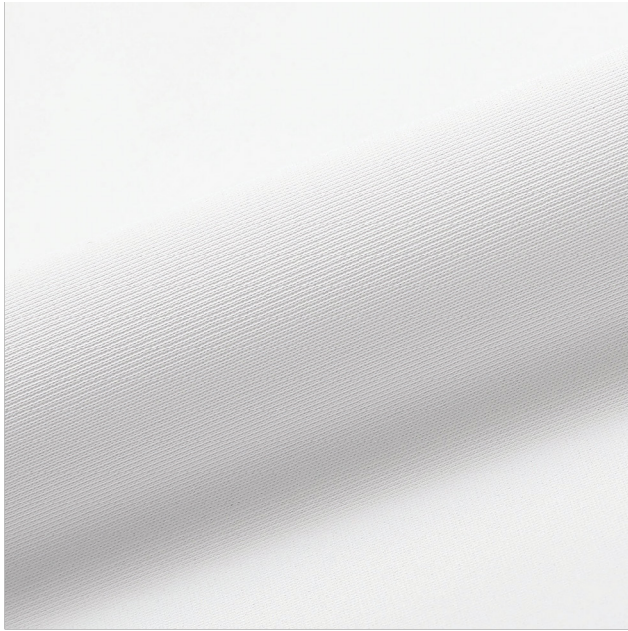

Color	White
Material	100% Knitted Polyester – coated (Recyclable)
Widths (inches)	126 & 199
Acoustic Rating	NRC = 0.85 (preliminary)
Fire Rating	ASTM E84 Class A
Printing Options	N/A
Cutting Methods	Cold
Order Code	STAT-RTR-xxx (xxx = width)

## Dust Layer

Additional inner layer to prevent dust and debris from reaching outer textile layer.



Color	White
Material	100% Knitted Polyester (Recyclable)
Widths (inches)	63, 126, & 199
Fire Rating	ASTM E84 Class A
Cutting Options	Cold, Ultrasonic, Heat
Order Code	STAT-DL-xxx (xxx = width)

## Acoustic Fleece

Provides acoustic absorption to optimize system performance.



Color	Black
Material	½" thick 100% PET (Recyclable)
Widths (inches)	48 (Roll = 100' length)
Fire Rating	ASTM E84 Class A
Order Code	STAT-FLC

## Acoustic Test Configuration

The acoustic performance values shown are based on the test configuration shown below.

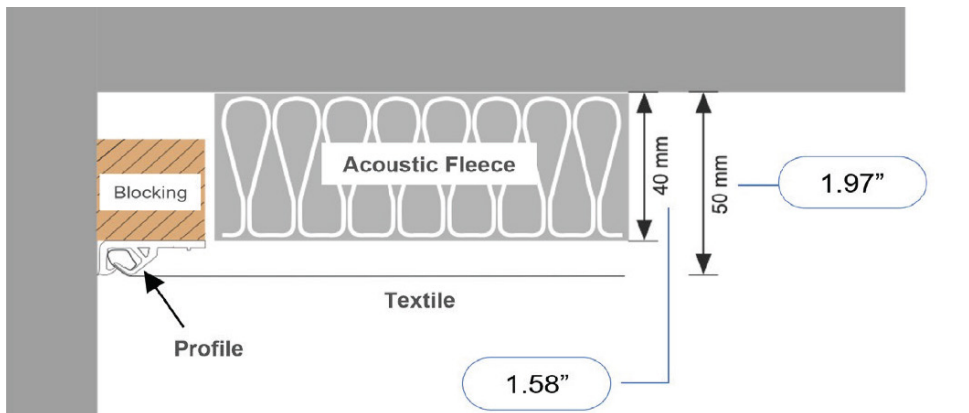

# Acoustic Ceilings

## Polymer Profiles

Lightweight mounting profiles with the option of staple attachment.

### Ceiling Mount



Color	Black or White
Material	Polypropylene*
Length	118.1" (9'-10.1")
Cross-section	0.39" x 1.18"
Packaging Units	50pcs or Individual
Order Code	STAT-PRF-CM

\*Architect friendly

### Wall Mount



Color	Black or White
Material	Polyvinyl Chloride
Length	118.1" (9'-10.1")
Cross-section	0.59" x 1.18"
Packaging Units	50pcs or Individual
Order Code	STAT-PRF-WM

### Flush Mount

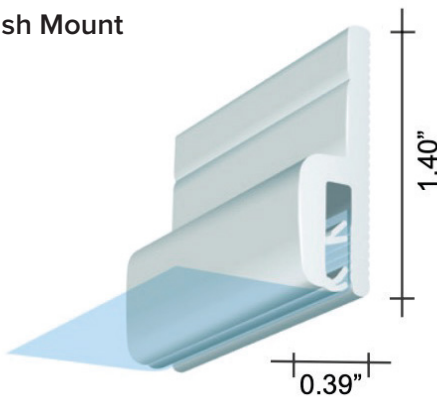

Color	White
Material	Polyvinyl Chloride
Length	118.1" (9'-10.1")
Cross-section	0.39" x 1.40"
Packaging Units	50pcs or Individual
Order Code	STAT-PRF-FM

# Acoustic Ceilings

## Aluminum Profiles

A selection that meets every project requirement.

### Knife Edge

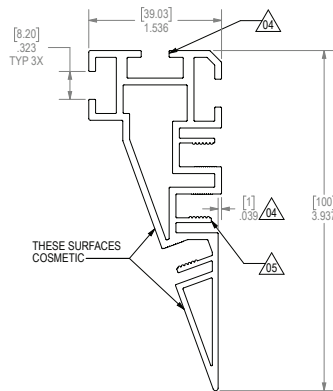

Finish	Mill Finish (MF) or Powdercoat (WH or BL)
Material	Aluminum
Length	119" (9'-11")
Cross-section	1.54" x 3.94"
Packaging Units	Individual
Order Code	STAT-PRF-KE-xx (MF, WH, BL)

### Flat 2"

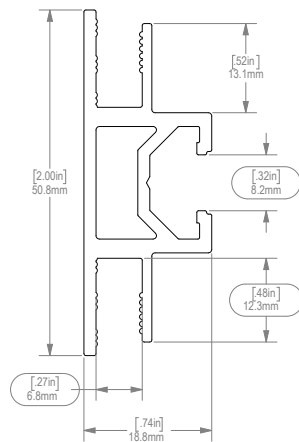

Finish	Mill Finish (MF) or Powdercoat (WH or BL)
Material	Aluminum
Length	119" (9'-11")
Cross-section	0.74" x 2.00"
Packaging Units	Individual
Order Code	STAT-PRF-FL2-xx (MF, WH, BL)

### Flat 4"

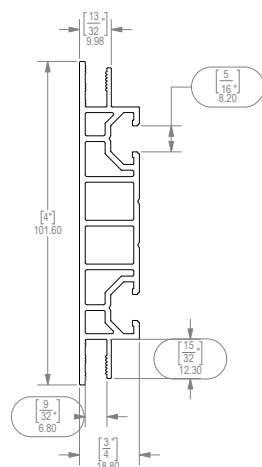

Finish	Mill Finish (MF) or Powdercoat (WH or BL)
Material	Aluminum
Length	119" (9'-11")
Cross-section	0.75" x 4.00"
Packaging Units	Individual
Order Code	STAT-PRF-FL4-xx (MF, WH, BL)